

HIGH EFFICIENCY

AC POWERED VENTURI FANS

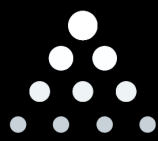

FOGCO

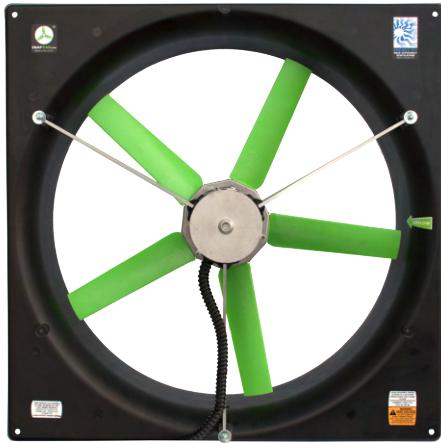

ENERGY FIT 6024 CFM 28" EC SNAP-FAN

- 30-70% more efficient than competing fans.
- High efficiency industrial grade Electronically Commutated Motor. 100-277 VAC 50/60 Hz.
- Motor made in USA. Water resistant, O-ring seals, IP54.
- Includes liquid tight conduit 5ft lead wires.
- Programmable motor can be set to run at a discrete speed from 350-1800 RPM and/or 0-10v controlled variable speed.
- Soft start, thermal roll back and locked rotor protection are standard features.
- Custom configuration options to fit your application.
- Patented low vibration aerodynamic motor mounting system reduces noise and improves efficiency.
- Glass reinforced polypropylene airfoil blade offers high efficiency and durability.
- Rugged corrosion resistant frame molded to maximize airflow.
- All parts serviceable and/or replaceable.
- Warranty of 5 years against parts and labor.

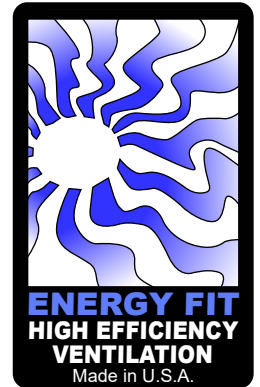

SNAP-FAN 12" / 16" / 20" / 24" / 28"

Fogco
600 S. 56th Street, Suite #9
Chandler, AZ 85226

T: (800) 607-6478
E: info@fogco.com
W: fogco.com



28" EC SNAP-FAN

120 VAC	STATIC PRESSURE (IN H2O)	AIRFLOW (CFM)	RPM	AMPS	WATTS	CFM/WATT
Factory Default	0.00	6024	940	4.04	300	20.08
	0.05	5554	931	4.14	307	18.07
	0.10	5026	928	4.18	311	16.18

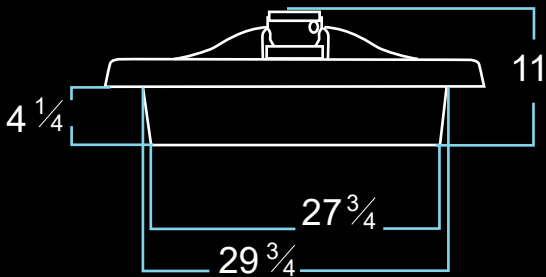
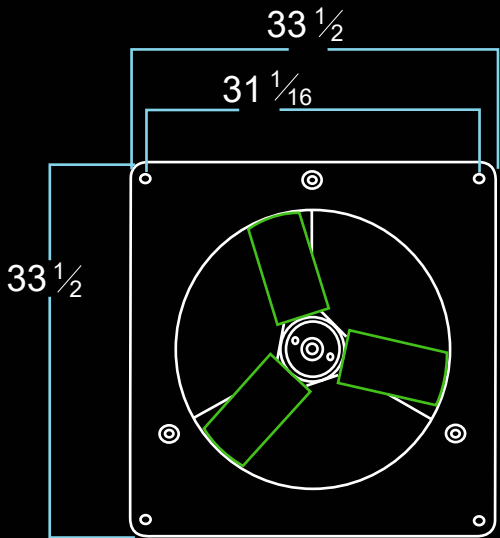

ELECTRICAL EQUIPMENT. CHECK WITH LOCAL BUILDING CODES AND YOUR LICENSED CONTRACTOR BEFORE INSTALLING.

HAND ASSEMBLED IN CHANDLER, AZ BY FOGCO PATENTED DESIGN

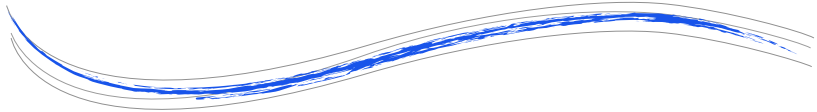
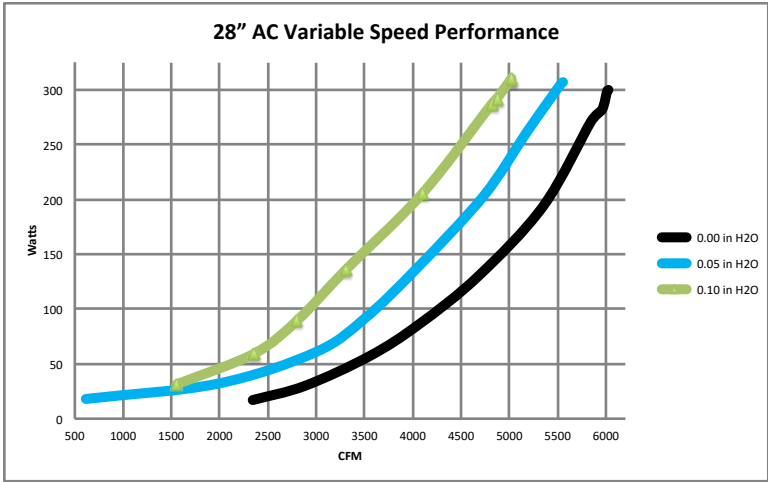

- ### Electronically Commutated Motor Features
- Patented design
 - Uses 40% - 60% less energy than PSC motors
 - Cooler operating temperatures
 - Longer motor life
 - Reduced warranty returns
 - Locked rotor, overload, and thermal roll back protection
 - Integrated control with sealed construction
 - Durable ball bearing construction for long commercial life
 - UL & CSA recognized
 - Designed and assembled in the USA